

Load CONTROLLER I™

by AIR LIFT®

Kit 25651

Dual Gauge Controller

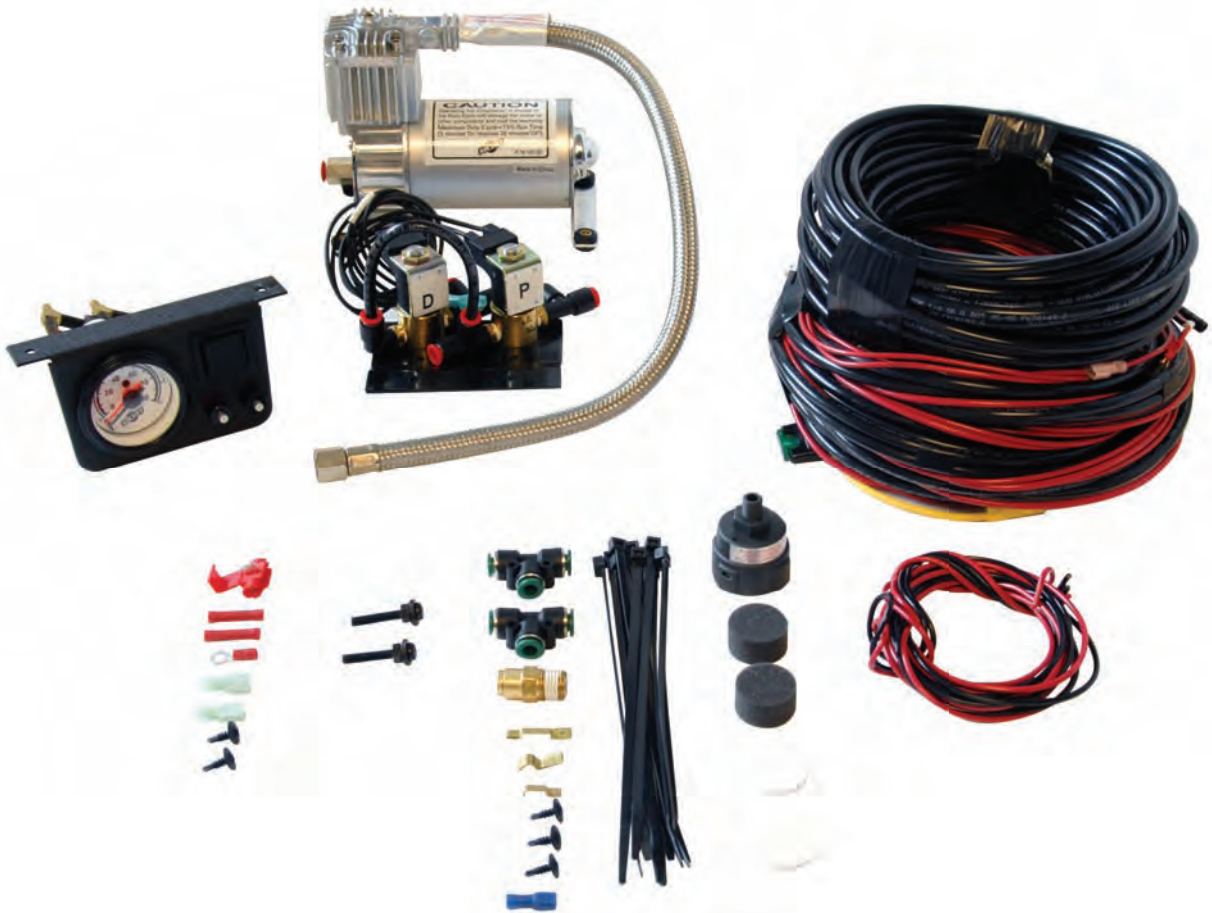

INSTALLATION GUIDE

For maximum effectiveness and safety, please read these instructions completely before proceeding with installation.

Failure to read these instructions can result in an incorrect installation.



TABLE OF CONTENTS

Introduction	2
Important Safety Notice	2
Notation Explanation	2
Installation Diagram	3
Hardware and Tools Lists	4
Installing the LoadController I System	5
Recommended Compressor Locations	5
Assembling and Mounting the Compressor	5
Mounting the Solenoid Valves	6
Grounding the Compressor and Solenoids	7
Installing the Air Line	7
Attaching the Air Line from the Compressor to the Solenoids	7
Installing the Grommet	8
Mounting the Gauge Panel	9
Routing the Harness	10
Connecting the Harness	11
Connecting the Air Line to the Air Springs	11
Connecting the Air Line to the Dash Panel	12
Connecting the Power Wire to the Fuse Box	13
Testing and Checking the System	13
Maintenance and Operations	14
Warranty and Returns Policy	15
Replacement Information	16
Contact Information	16

Introduction

The purpose of this publication is to assist with the installation, maintenance and troubleshooting of the LoadController I system.

It is important to read and understand the entire installation guide before beginning installation or performing any maintenance, service or repair. The information here includes a hardware list, tool list, step-by-step installation information, maintenance guidelines and operating tips.

Air Lift Company reserves the right to make changes and improvements to its products and publications at any time. For the latest version of this manual, contact Air Lift Company at (800) 248-0892 or visit our website at www.airliftcompany.com.

IMPORTANT SAFETY NOTICE

The installation of this kit does not alter the Gross Vehicle Weight Rating (GVWR) or payload of the vehicle. Check your vehicle's owner's manual and do not exceed the maximum load listed for your vehicle.

Gross Vehicle Weight Rating: The maximum allowable weight of the fully loaded vehicle (including passengers and cargo). This number — along with other weight limits, as well as tire, rim size and inflation pressure data — is shown on the vehicle's Safety Compliance Certification Label.

Payload: The combined, maximum allowable weight of cargo and passengers that the truck is designed to carry. Payload is GVWR minus the Base Curb Weight.

NOTATION EXPLANATION

Hazard notations appear in various locations in this publication. Information which is highlighted by one of these notations must be observed to help minimize risk of personal injury or possible improper installation which may render the vehicle unsafe. Notes are used to help emphasize areas of procedural importance and provide helpful suggestions. The following definitions explain the use of these notations as they appear throughout this guide.

 **DANGER**

INDICATES IMMEDIATE HAZARDS WHICH WILL RESULT IN SEVERE PERSONAL INJURY OR DEATH.

 **WARNING**

INDICATES HAZARDS OR UNSAFE PRACTICES WHICH COULD RESULT IN SEVERE PERSONAL INJURY OR DEATH.

 **CAUTION**

INDICATES HAZARDS OR UNSAFE PRACTICES WHICH COULD RESULT IN DAMAGE TO THE MACHINE OR MINOR PERSONAL INJURY.

NOTE

Indicates a procedure, practice or hint which is important to highlight.

Installation Diagram

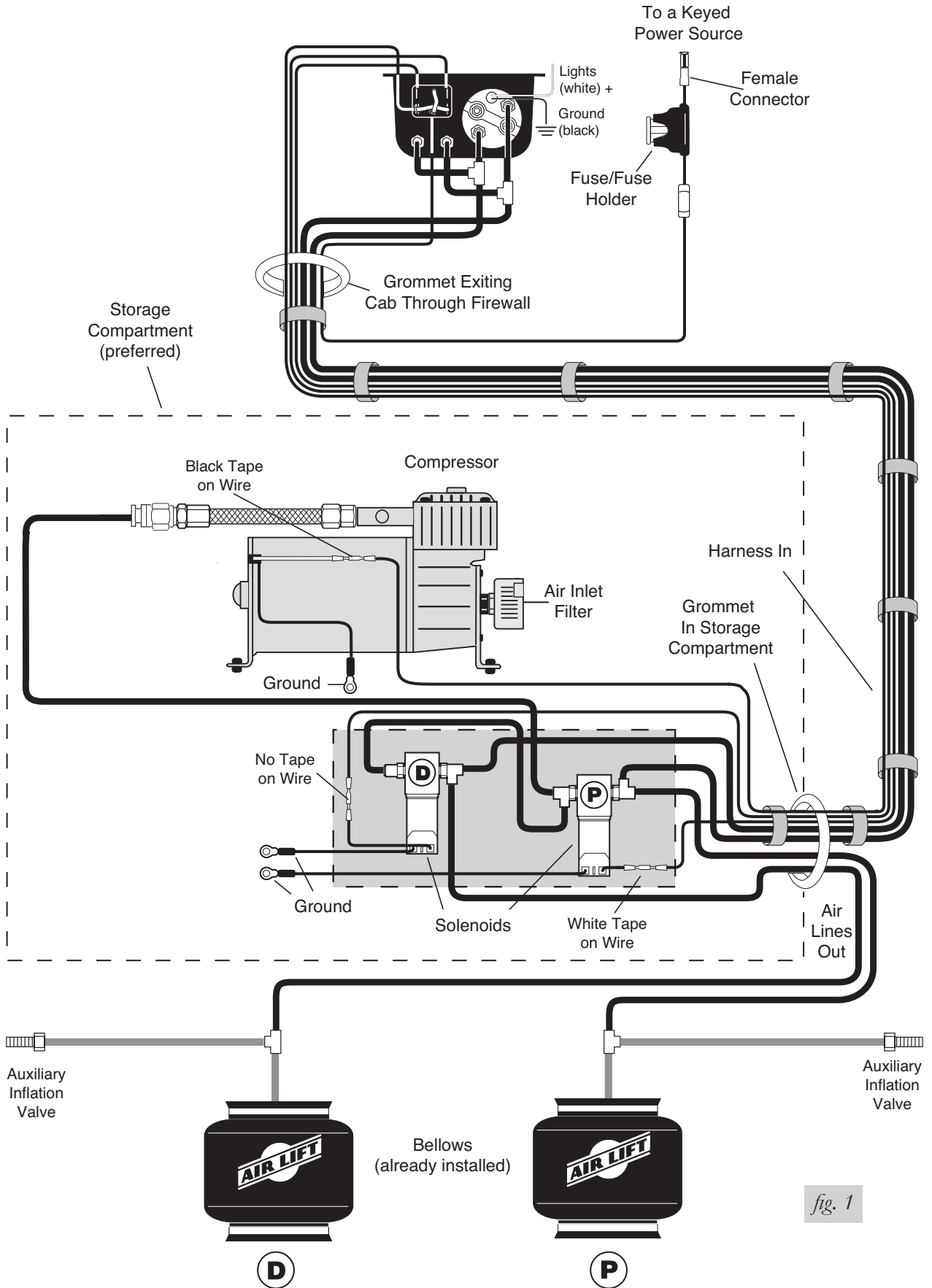

fig. 1

Hardware and Tools Lists

HARDWARE

Item	Description	Quantity
A	Gauge Panel/Harness Assembly	1
B	Compressor	1
C	1/8" MNPT 1/4" Straight Fitting	1
D	Air Filter	1
E	Bracket/Solenoid Assembly	1
G	#8 Silver Screws	4
H	8-32 Lock washer	4
I	Air Line	50'
J	Flexible Grommet	2
K	#8 Black Self Tapping Screws	3
L	Tee Fitting	2
M	Plastic Tie Straps	10
N	Fuse Adaptors	3
O	3/16" Female Terminal	1
P	Filter Fitting	1



TOOLS NEEDED

- 1/2", 13mm, 18mm, and 19mm open end or box wrenches
- Crescent wrench
- Ratchet with 3/8" and 1/2" deep well sockets
- 3/16", 3/32", and 1" drill bits (very sharp)
- Heavy duty drill
- Grinder
- Tin snips
- Phillips screw driver
- Hose cutter, razor blade, or sharp knife
- Hoist or floor jacks
- Safety stands
- Safety glasses
- Air compressor, or compressed air source
- Spray bottle with solution of 1/5 dish soap and 4/5 water



Missing or damaged parts? Call Air Lift customer service at (800) 248-0892 for a replacement part.

Installing the LoadController I System

RECOMMENDED COMPRESSOR LOCATIONS

Important

LOCATE COMPRESSOR IN DRY, PROTECTED AREA ON VEHICLE.
DIRECT SPLASH OR EXCESSIVE MOISTURE CAN DAMAGE
THE COMPRESSOR AND CAUSE SYSTEM FAILURE.

Disclaimer: If you choose to mount the compressor outside the vehicle please keep in mind the compressor body must be shielded from direct splash and the intake should be snorkeled inside the vehicle. If the compressor does not include a remote mount air filter or if mounting the compressor outside the vehicle, make sure to orient the compressor intake filter so that all moisture can easily drain.

Please also remember...

- To avoid high heat environments
- To avoid mounting the compressor under the hood.
- To check to be sure the compressor harness #2 will reach the compressor and connect to harness #1.
- The compressor can be mounted in any position — vertical, upside down, sideways, etc. (please refer to the instruction manual).

CAUTION

DO NOT EXCEED THE RECOMMENDED DUTY CYCLE OF 15% (3 MINUTES ON AND 20 MINUTES OFF). FAILURE TO COMPLY WITH THE RECOMMENDED DUTY CYCLE WILL CAUSE PREMATURE FAILURE OF THE COMPRESSOR. IN THE EVENT THAT THE COMPRESSOR STOPS RUNNING, IN ORDER TO RUN AGAIN, ALLOW THE COMPRESSOR TO COOL DOWN AND PROVIDE ADEQUATE TIME FOR THE THERMAL BREAKER TO RESET BEFORE TRYING TO START THE COMPRESSOR AGAIN.

NOTE

This kit is installed after the air springs have been installed. This manual is to be used in conjunction with the instruction manual included with each air spring kit.

ASSEMBLING AND MOUNTING THE COMPRESSOR

1. Select a rigid, protected, convenient mounting location for the compressor (B) under the vehicle (Fig. 2) or in a storage area (motorhomes) (Fig. 3). The location selected should shield the compressor from the elements.

NOTE

Be careful to shield the compressor from heat sources.

CAUTION

DO NOT MOUNT THE COMPRESSOR IN THE ENGINE COMPARTMENT. DOING SO CAN CAUSE PREMATURE FAILURE TO THE COMPRESSOR.



fig. 2

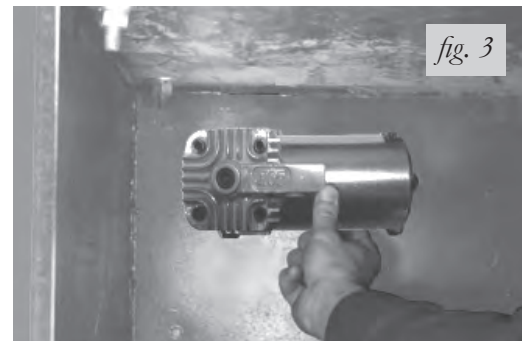
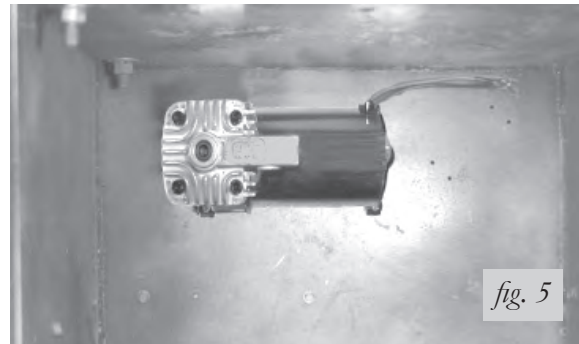
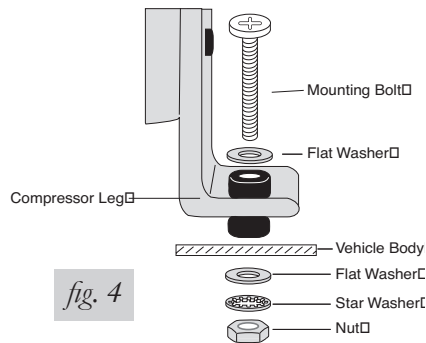
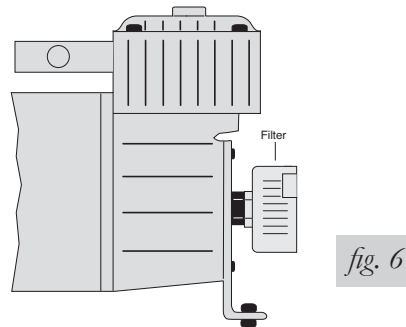

fig. 3

2. Use the four holes on the compressor legs as a template to mark the four mounting hole locations.
3. Center punch and drill four (4) $1\frac{3}{64}$ " holes.
4. Use screws provided to attach the compressor (Figs. 4 and 5).



5. Attach the filter (D) onto the compressor (B) (Fig. 6).



MOUNTING THE SOLENOID VALVES

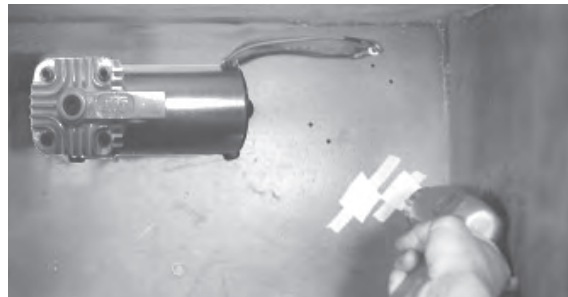

1. Select a mounting location for the solenoid bracket that contains the solenoids. The location selected should shield the solenoids from the elements.
2. Clamp the bracket in place and using the two outer holes in the bracket as a template, secure the solenoid brackets in the chosen location using two self-tapping screws.
3. Use the #8 silver screws (G) and the #8 lock washers (H) to secure the solenoids (E) in the chosen location (Fig. 8).

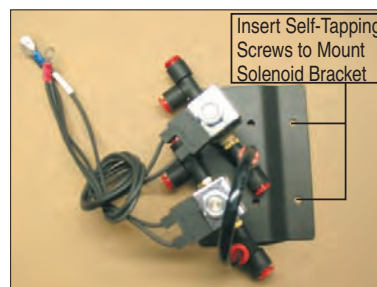

GROUNDING THE COMPRESSOR AND SOLENOIDS

- Using the provided #8 black self tapping screw (K), secure the ring terminal on the black wire from the compressor and the ring terminal connected to one of the wires from each solenoid to an adequate ground (metal fenderwell, frame, metal storage area).

INSTALLING THE AIR LINE

- Cut the air line into two equal parts.

CAUTION

WHEN CUTTING OR TRIMMING THE AIR LINE, USE A HOSE CUTTER (AIR LIFT P/N 10530), A RAZOR BLADE OR A SHARP KNIFE. A CLEAN, SQUARE CUT WILL ENSURE AGAINST LEAKS. (FIGURE 9A). DO NOT USE WIRE CUTTERS OR SCISSORS TO CUT THE AIR LINE. THESE TOOLS MAY FLATTEN OR CRIMP THE AIR LINE, CAUSING IT TO LEAK AROUND THE O-RING SEAL INSIDE THE ELBOW FITTING (FIG. 9B).

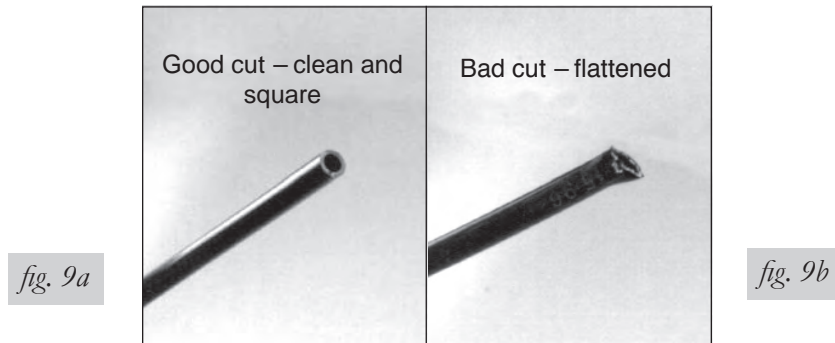

- Lubricate (i.e. soap, silicone spray, saliva) the end of the air line and insert it into the fitting (Fig. 10). Push firmly until you feel the resistance of the internal O-ring. Push harder and twist the air line slightly until you feel it move past the O-ring and seat. You will feel/hear it “click” into place. There will be $\frac{9}{16}$ ” of air line in the fitting when properly seated.

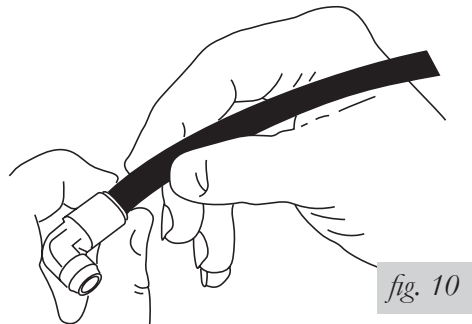

ATTACHING THE AIR LINE FROM THE COMPRESSOR TO THE SOLENOIDS

- Install the fitting (C) onto the compressor leader hose (Fig. 11). Install one end of the air line into the fitting. You will feel/hear it “click” into place. There will be $\frac{9}{16}$ ” of air line in the fitting when properly seated.

IMPORTANT: Only tighten the fitting 1 1/2 turns. Do not overtighten.

- Route the air line (I) to the passenger side solenoid (F) with two tee fittings installed on the solenoid (Fig. 12).

NOTE

If the solenoids are mounted within 3 feet or less of the compressor, use no less than 3 feet of tubing between the two.

IMPORTANT: Only tighten the fitting 1 1/2 turns. Do not overtighten.

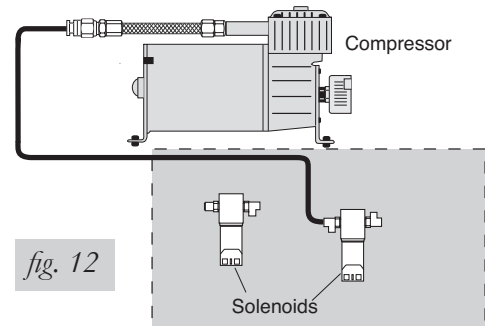
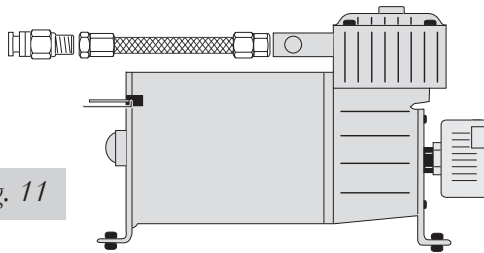

3. Cut off the excess air line and install the air line into one leg of one of the tees.
4. Install the remaining section piece of air line (I) onto the other leg of the same tee (Fig. 13).

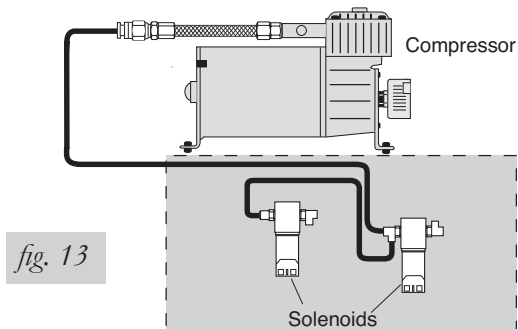

5. Route this air line to the straight fitting installed on the driver side solenoid (E) (Fig. 13).
6. Cut off excess air line and install the air line into the straight fitting.

INSTALLING THE GROMMET

1. Drill or cut a 1" diameter hole to route the harness into the compressor location (Fig.14).



2. Insert the flexible grommet material (J) and 'walk' the material around the inside edge of the hole (Fig. 15).

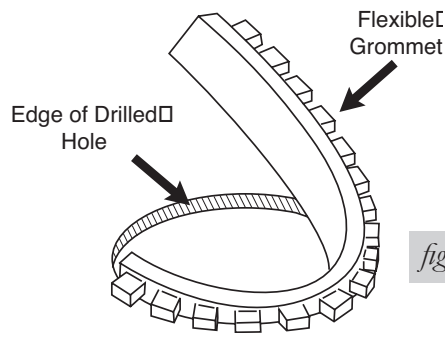

fig. 15

3. Cut off any excess grommet material (Fig. 16).

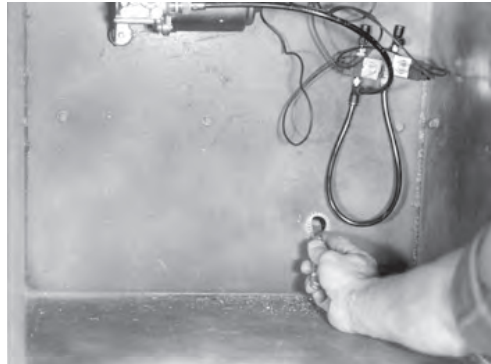

fig. 16

MOUNTING THE GAUGE PANEL

IMPORTANT: All preassembled gauge panels have been 100% leak and function tested. Do not attempt to tighten, loosen, or adjust any fittings or connections. This will likely cause a leak or malfunction and void the warranty.

1. The gauge panel has been preassembled for your convenience.
2. The following is the attaching sequence for the system:
Non-taped wire to terminal #4, white taped wire to terminal #6, black taped wire to terminal #3, and the other non-taped wire to terminal #2 (Fig. 17).

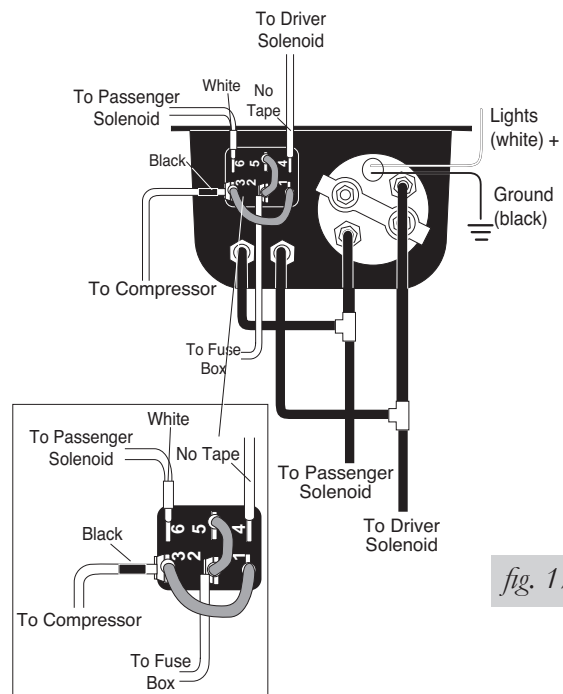

fig. 17

ROUTING THE HARNESS

1. Route the harness (A) from the dash panel through an existing grommet in the floorboard or firewall (Fig. 18).

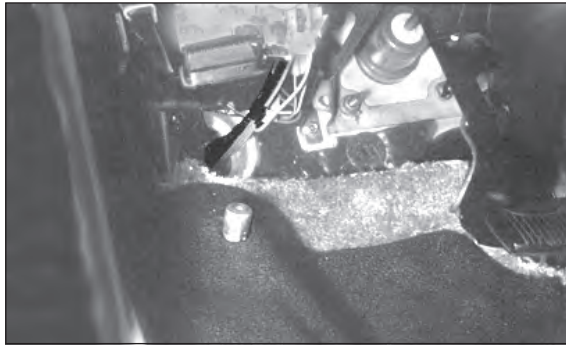

fig. 18

NOTE

In some cases a hole may have to be drilled or cut to allow access for the harness. Drill or cut a 1" diameter hole and install the provided flexible grommet (J). It will be necessary to seal any grommets or holes that have been cut, drilled or removed so as not to allow elements to enter the cab area of the vehicle.

2. Route the harness (A) along the frame rail. Keep away from heat (exhaust system, etc.) and moving chassis components. Secure harness to frame with plastic tie straps (M) provided (Fig. 19).

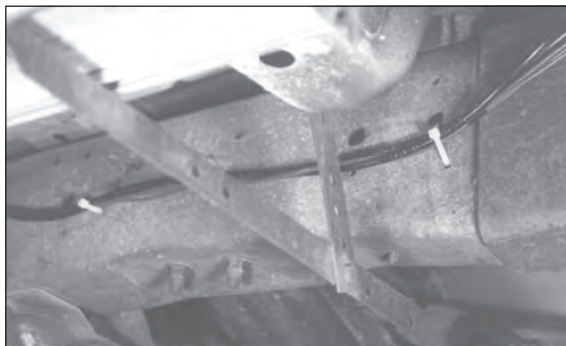

fig. 19

3. Route the harness through the previously installed grommet to the compressor and solenoid location (Fig. 20).



fig. 20

4. Select a convenient sturdy mounting location for the dash panel (A). Using the holes in the gauge panel as a template, drive in the two #8 black self tapping screws (K) (Fig. 21).



fig. 21

CONNECTING THE HARNESS

1. Connect the wires on the harness to the wires of the compressor and solenoids by color and terminals (black to black, no tape to no tape, white to white, etc). Refer to Fig. 22.

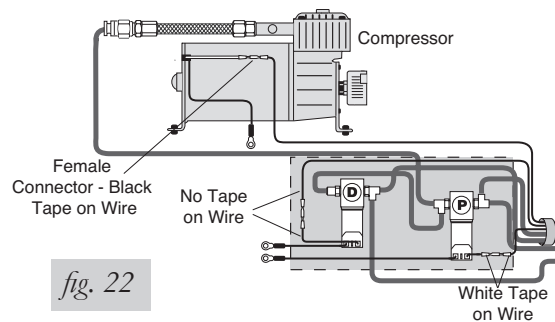

fig. 22

CONNECTING THE AIR LINE TO THE AIR SPRINGS

1. Deflate each air spring. Cut the air line already installed between air spring and inflation valve. Install a tee fitting (L) (Fig. 23). Follow this same procedure for air line leading to the other air spring, and inflation valve.

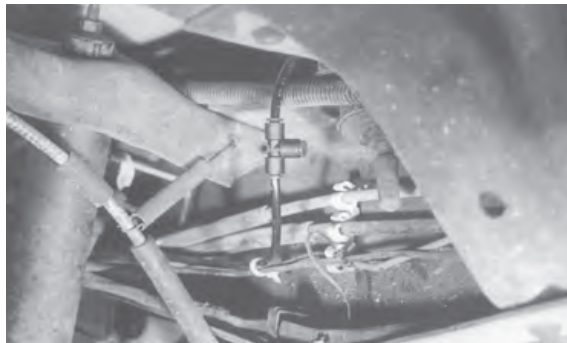

fig. 23

2. Install remaining length of air line into open leg of the tee previously installed between the air spring and the inflation valve. Route the air line along the frame and secure with nylon tie straps (M) to the solenoid (Fig. 24 - see next page).
3. Install the air line from the driver side air spring into one of the open legs of the driver side solenoid (Fig. 25 - see next page).
4. Install the air line from the passenger side air spring into one of the open ports of the passenger side solenoid (Fig. 25).



fig. 24

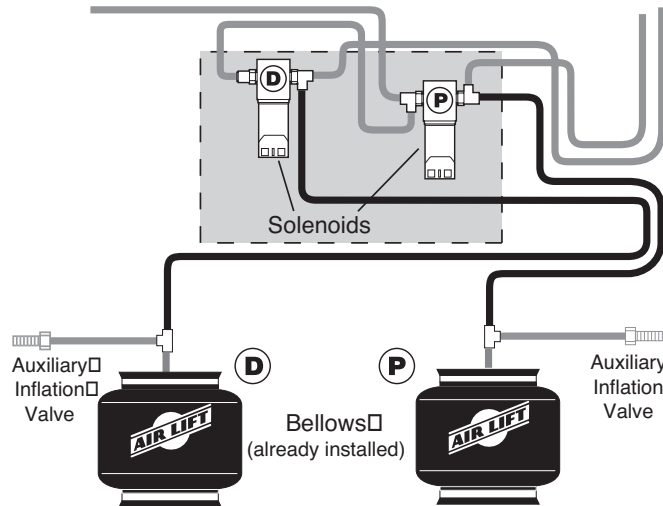

fig. 25

CONNECTING THE AIR LINE TO THE DASH PANEL

1. Connect the white-taped air line to the one open leg of the tee fitting on passenger side solenoid (Fig. 26).

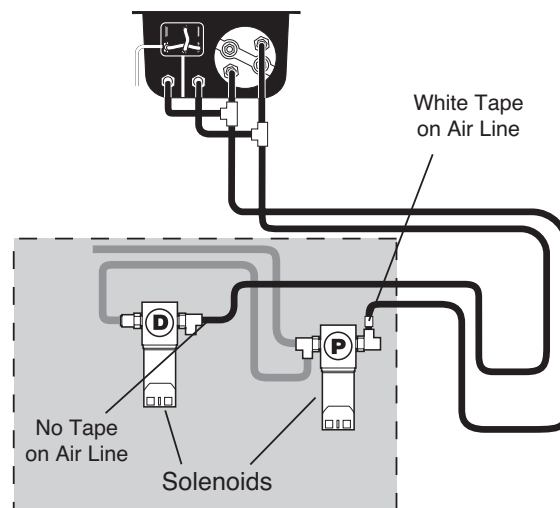

fig. 26

2. Connect the air line with no tape to the open leg of the tee fitting on the driver side solenoid (Fig. 26).
3. Route the white wire for the illuminated gauge to an accessory power source. Attach the black wire to an adequate ground.

CONNECTING THE POWER WIRE TO THE FUSE BOX

1. Use a test light to determine which open terminal (accessory, etc.) works only when the key is in the "on" or accessory position (Fig. 27). The terminal should have an amperage rating equal to or higher than the 25 amp inline fuse.

NOTE

Connect the adapter to the "Hot" side of the fuse (use test light to determine).



fig. 27

2. Connection to the fuse terminal will depend on what type of fuse your vehicle uses (Fig. 28).

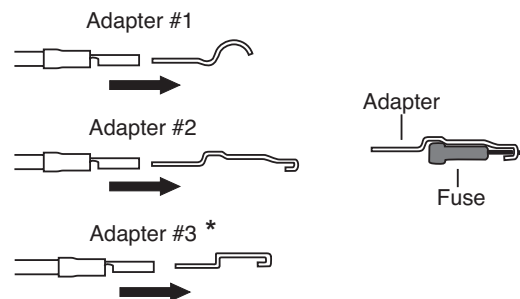

* Uses 3/16" (smaller) Female Push On Connector

- a. If your vehicle uses a barrel type fuse, use adapter #1.
 - b. If you have the standard spade type fuses, use adapter #2.
 - c. Many late model vehicles use a smaller spade type fuse which requires adapter #3 (N) and the 3/16" female terminal provided (O).
3. Turn ignition key on momentarily to test electrical circuit and check the air compressor by pushing the toggle switch to the right or left and holding it. If it runs, turn it off by releasing the switch. If the compressor does not run, use a test light to determine that there is power to both sides of the switch. Insure that the ground (black) wire is providing a sufficient ground.
 4. **IMPORTANT: Do not exceed the recommended duty cycle of 15% (3 minutes on and 20 minutes off).**

CAUTION

FAILURE TO COMPLY WITH THE RECOMMENDED DUTY CYCLE WILL CAUSE PREMATURE FAILURE OF THE COMPRESSOR.

TESTING AND CHECKING THE SYSTEM

1. Push the toggle switch to the left and watch pressure increase on the left air gauge. Inflate to 60 p.s.i. Push switch to the right and inflate right side to 60 p.s.i. **Due to weight transferring, the air pressure in the first air spring inflated will change as you inflate the other side.**
2. Check the following locations for leaks by spraying them with a solution of 1/5 dish soap to 4/5 water: air line connections at each solenoid, air line connection at the compressor,

air line connections at the back of the dash panel, and each tee fitting location (Fig. 29). If bubbles appear and grow, then see step 3 below on how to repair the leaks.

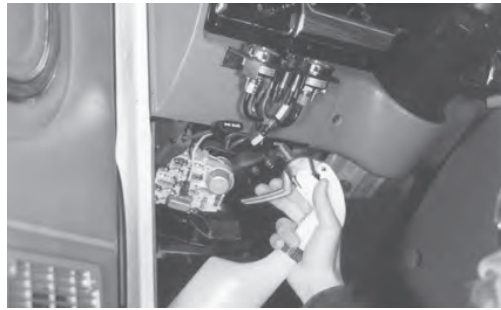

fig. 29

3. If there are any fitting leaks, then:
 - a. Deflate the spring and remove the line by pulling the collar against the fitting and pulling firmly on the air line.
 - b. Trim $\frac{1}{2}$ " off the end of the air line. Be sure the cut is clean and spare.
 - c. Reinsert air line into the push-to-connect fitting ($\frac{9}{16}$ ").

MAINTENANCE AND OPERATIONS

NOTE

This manual is to be used in conjunction with the instruction manual included with each air spring kit.

1. Inflation:

To inflate the air spring on one side of the vehicle, push the toggle switch side ways on the dash panel. The compressor will turn on automatically to increase the pressure as indicated on the gauge. Once the desired pressure is reached release the button and the compressor will shut off. **Due to weight transferring, the air pressure in the first air spring inflated will change as you inflate the other side.**
2. Deflation:

To deflate one side of the vehicle, depress the deflate button on the side you want decrease.
3. In the event that the compressor stops running, in order to run again allow the compressor to cool down and provide adequate time for the thermal breaker to reset before trying to start the compressor again.
4. Air Lift Design Intent:

All AIR LIFT kits are designed to maintain the vehicle at Normal Ride Height with additional loading up to, but not to exceed, the maximum gross vehicle weight as identified by the manufacturer on the vehicle chassis.
5. Correct Air Pressure:

Remove unusual loads and examine your vehicle from the side to ensure it is on a level surface. If necessary (in cases where your leaf springs are sagging badly), use a jack to raise the rear end so that the vehicle achieves the original as delivered ride height.

Correct air pressure is ensured when the vehicle is at Normal Ride Height. Normal Ride Height is the distance between the bottom edge of the wheel well and the center of the hub with the vehicle in the as delivered condition. In some cases, Normal Ride Height is not perfectly level. Record this height (Fig. 30). Inflate or deflate the air springs until the vehicle is at Normal Ride Height. Loaded or unloaded, Normal Ride Height should always be maintained.

NORMAL
RIDE HEIGHT: _____ inches



fig. 30



Warranty and Returns Policy

Air Lift Company warrants its products, for the time periods listed below, to the original retail purchaser against manufacturing defects when used on catalog-listed applications on cars, vans, light trucks and motorhomes under normal operating conditions for as long as Air Lift manufactures the product. The warranty does not apply to products that have been improperly applied, improperly installed, used in racing or off-road applications, used for commercial purposes, or which have not been maintained in accordance with installation instructions furnished with all products. The consumer will be responsible for removing (labor charges) the defective product from the vehicle and returning it, transportation costs prepaid, to the dealer from which it was purchased or to Air Lift Company for verification.

Air Lift will repair or replace, at its option, defective products or components. A minimum \$10.00 shipping and handling charge will apply to all warranty claims. Before returning any defective product, you must call Air Lift at (800) 248-0892 in the U.S. and Canada (elsewhere, (517) 322-2144) for a Returned Materials Authorization (RMA) number. Returns to Air Lift can be sent to: Air Lift Company • 2727 Snow Road • Lansing, MI • 48917.

Product failures resulting from abnormal use or misuse are excluded from this warranty. The loss of use of the product, loss of time, inconvenience, commercial loss or consequential damages is not covered. The consumer is responsible for installation/reinstallation (labor charges) of the product. Air Lift Company reserves the right to change the design of any product without assuming any obligation to modify any product previously manufactured.

This warranty gives you specific legal rights and you may also have other rights that vary from state-to-state. Some states do not allow limitations on how long an implied warranty lasts or allow the exclusion or limitation of incidental or consequential damages. The above limitation or exclusion may not apply to you. There are no warranties, expressed or implied including any implied warranties of merchantability and fitness, which extend beyond this warranty period. There are no warranties that extend beyond the description on the face hereof. Seller disclaims the implied warranty of merchantability. (Dated proof of purchase required.)

Air Lift 1000.....	Lifetime Limited	LoadController/Dual.....	2 Year Limited
RideControl.....	Lifetime Limited	Load Controller (I).....	2 Year Limited
LoadLifter 5000*.....	Lifetime Limited	Load Controller (II).....	2 Year Limited
SlamAir.....	Lifetime Limited	SmartAir.....	2 Year Limited
AirCell.....	Lifetime Limited	Wireless AIR.....	2 Year Limited
Lifestyle & Performance**....	1 Year Limited	WirelessONE.....	2 Year Limited
LoadController/Single.....	2 Year Limited	Other Accessories.....	2 Year Limited

**formerly SuperDuty*
***formerly EasyStreet*

Replacement Information

If you need replacement parts, contact the local dealer or call Air Lift customer service at (800) 248-0892. Most parts are immediately available and can be shipped the same day.

Contact Air Lift Company customer service at (800) 248-0892 first if:

- Parts are missing from the kit.
- Need technical assistance on installation or operation.
- Broken or defective parts in the kit.
- Wrong parts in the kit.
- Have a warranty claim or question.

Contact the retailer where the kit was purchased:

- If it is necessary to return or exchange the kit for any reason.
- If there is a problem with shipping if shipped from the retailer.
- If there is a problem with the price.

Contact Information

If you have any questions, comments or need technical assistance contact our customer service department by calling (800) 248-0892, Monday through Friday, 8 a.m. to 7 p.m. Eastern Time. For calls from outside the USA or Canada, our local number is (517) 322-2144.

For inquiries by mail, our address is PO Box 80167, Lansing, MI 48908-0167. Our shipping address for returns is 2727 Snow Road, Lansing, MI 48917.

You may also contact us anytime by e-mail at sales@airliftcompany.com or on the web at www.airliftcompany.com.

Need Help?

Contact our customer service department by calling (800) 248-0892, Monday through Friday, 8 a.m. to 7 p.m. Eastern Time. For calls from outside the USA or Canada, our local number is (517) 322-2144.

**Register your warranty online at
www.airliftcompany.com/warranty**



Thank you for purchasing Air Lift products — the professional installer's choice!

Air Lift Company • 2727 Snow Road • Lansing, MI 48917 or PO Box 80167 • Lansing, MI 48908-0167
Toll Free (800) 248-0892 • Local (517) 322-2144 • Fax (517) 322-0240 • www.airliftcompany.com

Printed in
the USA